

Discovery kit for STM32L0 series with STM32L053C8 MCU

Introduction

The STM32L053 discovery kit (32L0358DISCOVERY) helps you to discover the full features of the STM32L0 series and to develop your applications. It is based on an STM32L053C8T6 and includes an ST-LINK/V2-1 embedded debug tool interface, linear touch sensor, touch keys, IDD current measurement, 2.04" E-paper display, NFC connector for PLUG-CR95HF-B board, LEDs, pushbuttons and an USB mini-B connector.

Figure 1. STM32L053 discovery board

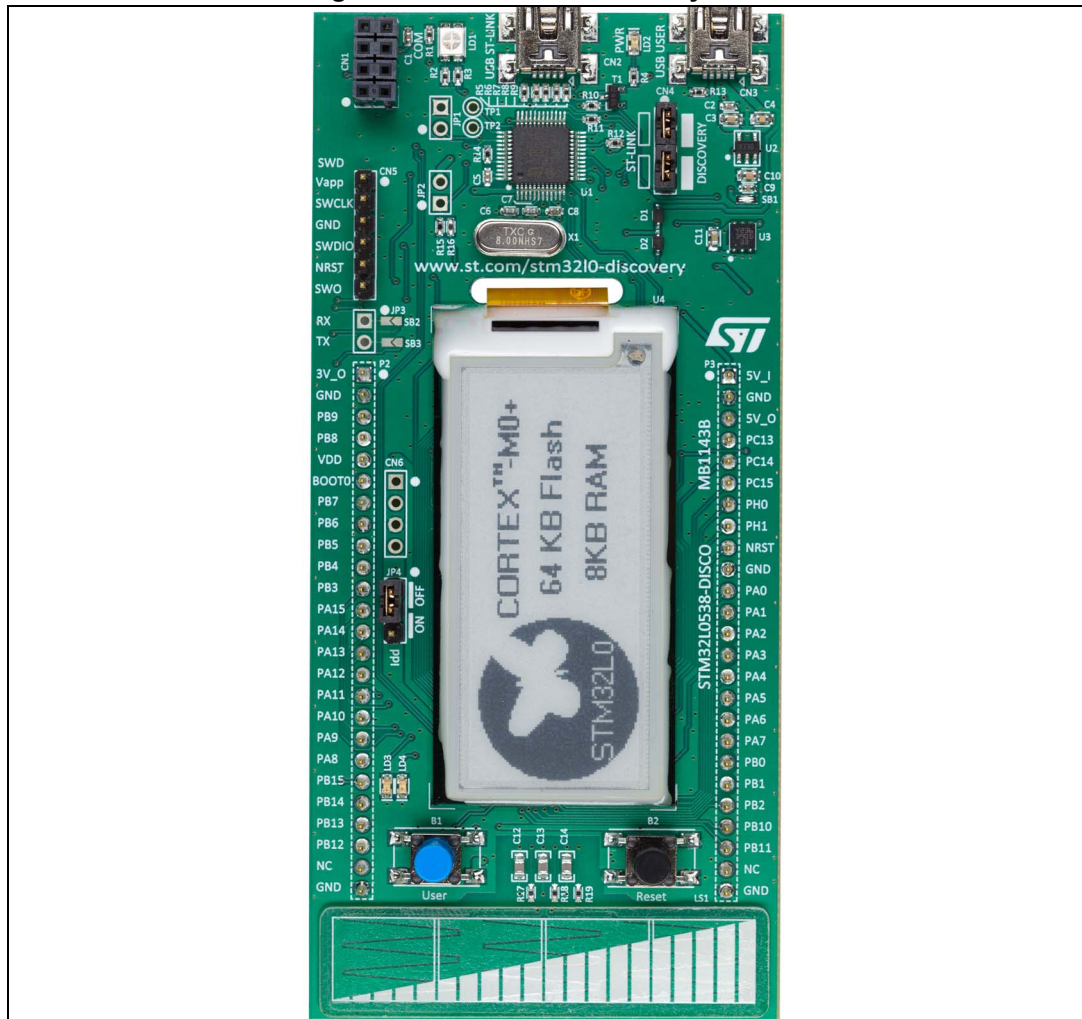

Contents

- 1 Conventions 6**
- 2 Ordering and product information 7**
 - 2.1 Order code 7
- 3 Features 8**
- 4 Hardware layout 9**
 - 4.1 Embedded ST-LINK/V2-1 12
 - 4.1.1 Drivers 12
 - 4.1.2 ST-LINK/V2-1 firmware upgrade 13
 - 4.1.3 Using ST-LINK/V2-1 to program/debug the STM32L053 on board ... 14
 - 4.1.4 Using ST-LINK/V2-1 to program/debug an external STM32 application 15
 - 4.2 Power supply and power selection 16
 - 4.2.1 Power supply input from the USB connector 17
 - 4.2.2 External power supply inputs: 5V_IN or USB USER CN3 17
 - 4.3 LEDs 18
 - 4.4 Pushbuttons 18
 - 4.5 NFC connector for PLUG-CR95HF-B board 19
 - 4.6 Electronic Paper Display (EPD) 20
 - 4.7 JP4 (Idd) 20
 - 4.8 BOOT0 configuration 21
 - 4.9 Linear touch sensor / touch keys 21
 - 4.10 USB device support 22
 - 4.11 USART configuration 22
 - 4.12 OSC clock supply 22
 - 4.13 OSC 32 kHz clock supply 23
 - 4.14 Solder bridges 24
 - 4.15 Extension connectors 25
- 5 Mechanical drawing 31**
- 6 Electrical schematics 32**

7 Revision history 38

List of tables

Table 1.	ON/OFF conventions	6
Table 2.	Jumper states	12
Table 3.	Debug connector CN5 (SWD)	15
Table 4.	NFC connector pin-out	20
Table 5.	Solder bridges.	24
Table 6.	Extension connectors	25
Table 7.	Document revision history	38

List of figures

Figure 1.	STM32L053 discovery board	1
Figure 2.	STM32L053 discovery hardware block diagram.	9
Figure 3.	Top layout	10
Figure 4.	Bottom layout	11
Figure 5.	Updating the list of drivers in device manager	13
Figure 6.	STM32L053 discovery board connections	14
Figure 7.	ST-LINK connections	16
Figure 8.	NFC board plugged on STM32L053 discovery.	19
Figure 9.	Jumper on position OFF	20
Figure 10.	Jumper on position ON	21
Figure 11.	No Jumper	21
Figure 12.	STM32L053 discovery board mechanical drawing	31
Figure 13.	STM32L053 discovery	32
Figure 14.	ST-LINK/V2-1 (SWD only)	33
Figure 15.	STM32L053C8T6 MCU	34
Figure 16.	Electronic paper display	35
Figure 17.	Linear touch sensor, NFC, USB and pushbutton	36
Figure 18.	IDD measurement / MFX (Multi Function eXpander)	37

1 Conventions

[Table 1](#) provides the definition of some conventions used in the present document.

Table 1. ON/OFF conventions

Convention	Definition
Jumper JPx ON	Jumper fitted
Jumper JPx OFF	Jumper not fitted
Solder bridge SBx ON	SBx connections closed by Solder
Solder bridge SBx OFF	SBx connections left open

2 Ordering and product information

The STM32L053 discovery is a low-cost and easy-to-use development kit to quickly evaluate and start a development with an STM32L0 series microcontroller.

Before installing and using the product, please accept the Evaluation Product License Agreement from www.st.com/stm32l0-discovery.

For more information on the STM32L053 discovery board and for demonstration software, visit www.st.com/stm32l0-discovery.

2.1 Order code

To order the STM32L053 discovery kit, use the order code: STM32L0538-DISCO.

3 Features

The STM32L053 discovery board offers the following features:

- STM32L053C8T6 microcontroller featuring 64 KB of flash memory, 8 KB of RAM in an LQFP48 package
- On-board ST-LINK/V2-1 with selection mode switch to use the kit as a standalone ST-LINK/V2-1 (with SWD connector for programming and debugging)
- USB re-enumeration capability: three different interfaces supported on USB
 - Virtual com port
 - Mass storage
 - Debug port
- Board power supply: through USB bus or from an external 5 V supply voltage
- External application power supply: 3 V and 5 V
- One linear touch sensor or four touch keys.
- IDD current measurement.
- 2.04" E-paper Display, 172x72 pixels.
- NFC connector for PLUG-CR95HF-B board.
- USB USER with Mini-B connector.
- Four LEDs:
 - LD1 (red/green) for USB communication
 - LD2 (red) for 3.3 V power on
 - Two user LEDs: LD3 (green), LD4 (red)
- Two pushbuttons (user and reset)
- Extension header for LQFP48 I/Os for a quick connection to the prototyping board and easy probing.

4 Hardware layout

The STM32L053 discovery board has been designed around the STM32L053C8T6 microcontroller in a 48-pin LQFP package.

Figure 2 illustrates the connections between the STM32L053C8T6 and its peripherals (ST-LINK/V2-1, linear touch sensor, touch keys, IDD current measurement, 2.04" E-paper display, NFC connector for PLUG-CR95HF-B board, LEDs, pushbuttons and an USB mini-B connector).

Figure 3 and *Figure 4* help you to locate these features on the STM32L053 discovery board.

Figure 2. STM32L053 discovery hardware block diagram

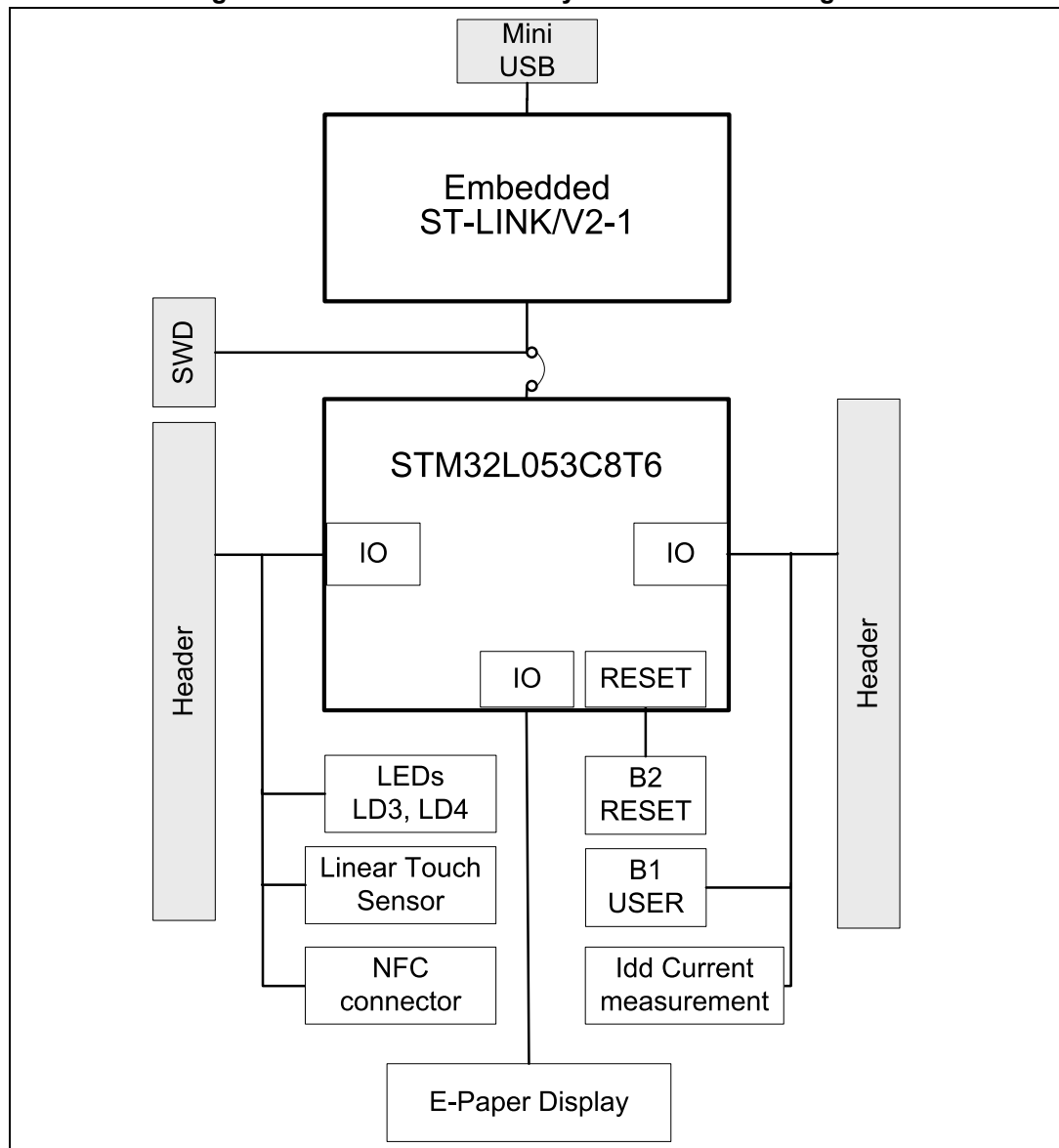
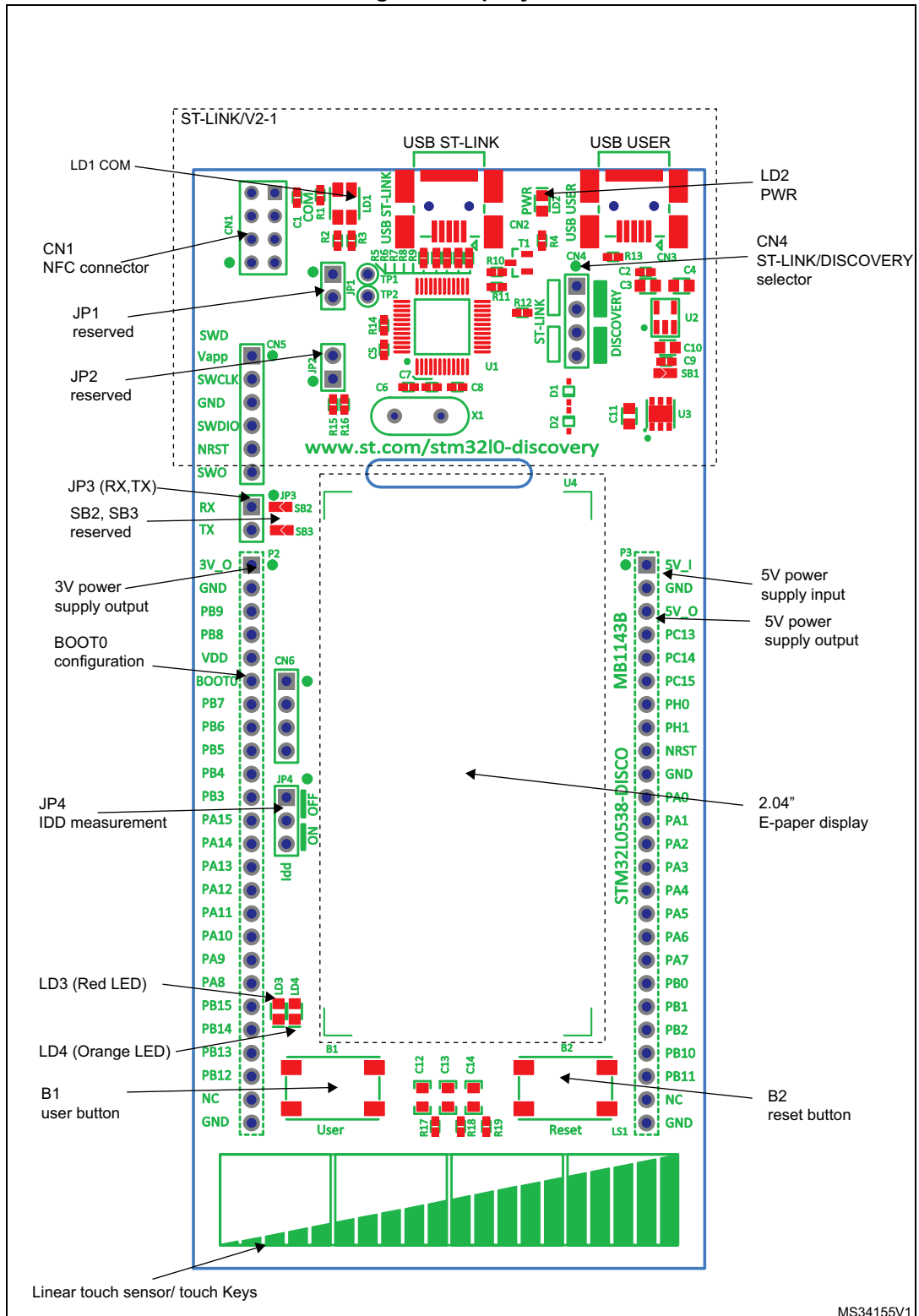
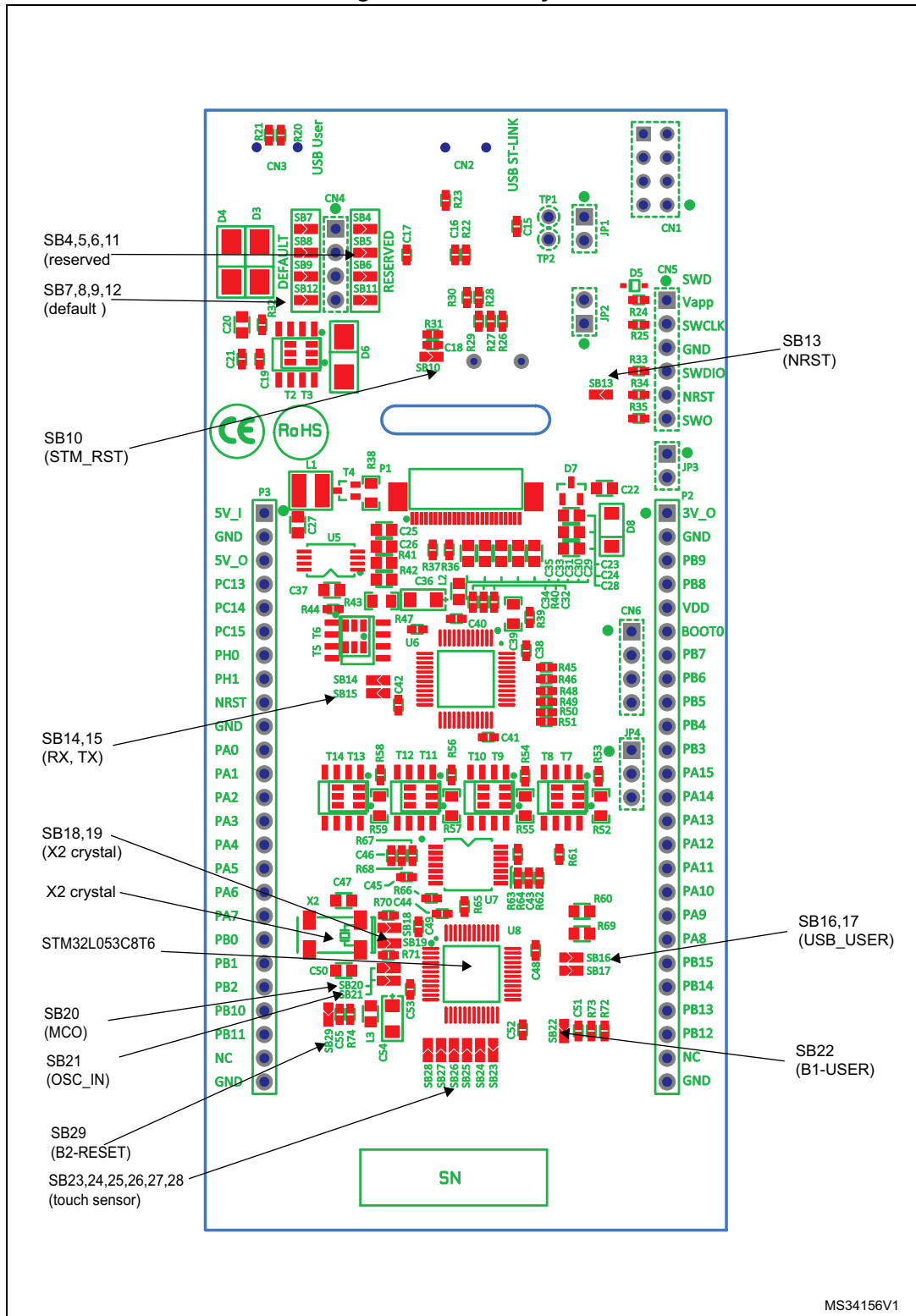

Figure 3. Top layout



MS34155V1

Figure 4. Bottom layout



SB4,5,6,11
(reserved)
SB7,8,9,12
(default)

SB10
(STM_RST)

SB14,15
(RX, TX)

SB18,19
(X2 crystal)

X2 crystal

STM32L053C8T6

SB20
(MCO)

SB21
(OSC_IN)

SB29
(B2-RESET)

SB23,24,25,26,27,28
(touch sensor)

SB13
(NRST)

SB16,17
(USB_USER)

SB22
(B1-USER)

MS34156V1



4.1 Embedded ST-LINK/V2-1

The ST-LINK/V2-1 programming and debugging tool is integrated on the STM32L053 discovery board.

The embedded ST-LINK/V2-1 supports only SWD for STM32 devices. For information about debugging and programming features, refer to user manual UM1075 (ST-LINK/V2 in-circuit debugger/programmer for STM8 and STM32) which describes in detail all the ST-LINK/V2 features.

The changes versus ST-LINK/V2 version are listed below.

- New features supported on ST-LINK/V2-1:
 - USB software re-enumeration
 - Virtual com port interface on USB
 - Mass storage interface on USB
 - USB power management request for more than 100 mA power on USB
- Features not supported on ST-LINK/V2-1:
 - SWIM interface
 - Minimum supported application voltage limited to 3 V

There are two different ways to use the embedded ST-LINK/V2-1 depending on the jumper states (see [Table 2](#)):

- Program/debug the MCU on board ([Section 4.1.3](#)).
- Program/debug an MCU in an external application board using a cable connected to SWD connector CN5 ([Section 4.1.4](#)).

Table 2. Jumper states

Jumper state	Description
Both CN4 jumpers ON	ST-LINK/V2-1 functions enabled for on board programming (default)
Both CN4 jumpers OFF	ST-LINK/V2-1 functions enabled for application through external CN5 connector (SWD supported)

4.1.1 Drivers

The ST-LINK/V2-1 requires a dedicated USB driver, which can be found on www.st.com for Windows Vista, 7 and 8. On Windows XP the ST-LINK/V2-1 driver requires WinUsb to be installed before using the ST-LINK/V2-1 (either available from Microsoft website or included in the USB driver for ST-LINK/V2 for XP).

In case the STM32L053 discovery board is connected to the PC before the driver is installed, some discovery interfaces may be declared as “Unknown” in the PC device manager. In this case the user must install the driver files ([Figure 5](#)), and from the device manager update the driver of the connected device.

Note: Prefer using the “USB Composite Device” handle for a full recovery.

Figure 5. Updating the list of drivers in device manager

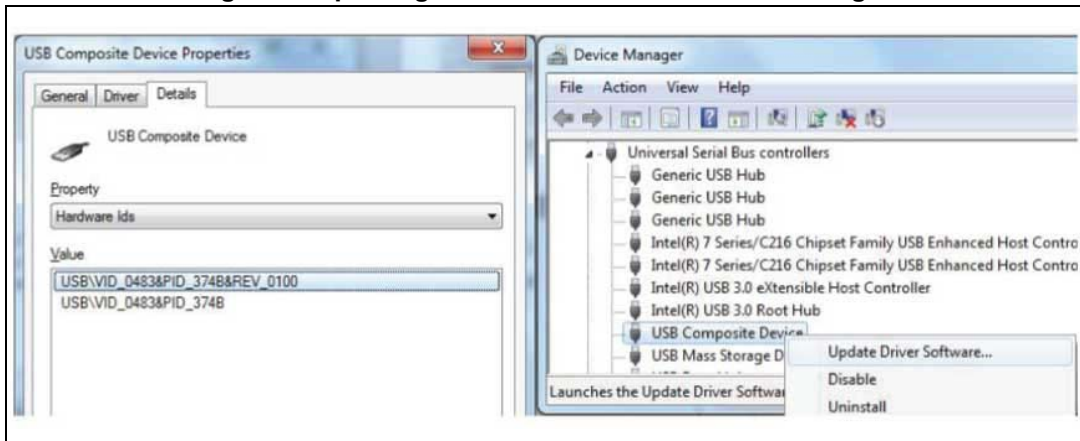

4.1.2 ST-LINK/V2-1 firmware upgrade

The ST-LINK/V2-1 embeds a firmware upgrade mechanism for in-situ upgrade through the USB port. As the firmware may evolve during the life time of the ST-LINK/V2-1 product (for example new functionality, bug fixes, support for new microcontroller families), it is recommended to visit www.st.com at the board delivery, then periodically in order to stay up-to-date with the latest firmware version.

4.1.3 Using ST-LINK/V2-1 to program/debug the STM32L053 on board

To program the STM32L053 on board, simply plug in the two jumpers on CN4, as shown in [Figure 6](#) in red, but do not use the CN5 connector as that could disturb communication with the STM32L053C8T6 of the STM32L053 discovery board.

Figure 6. STM32L053 discovery board connections

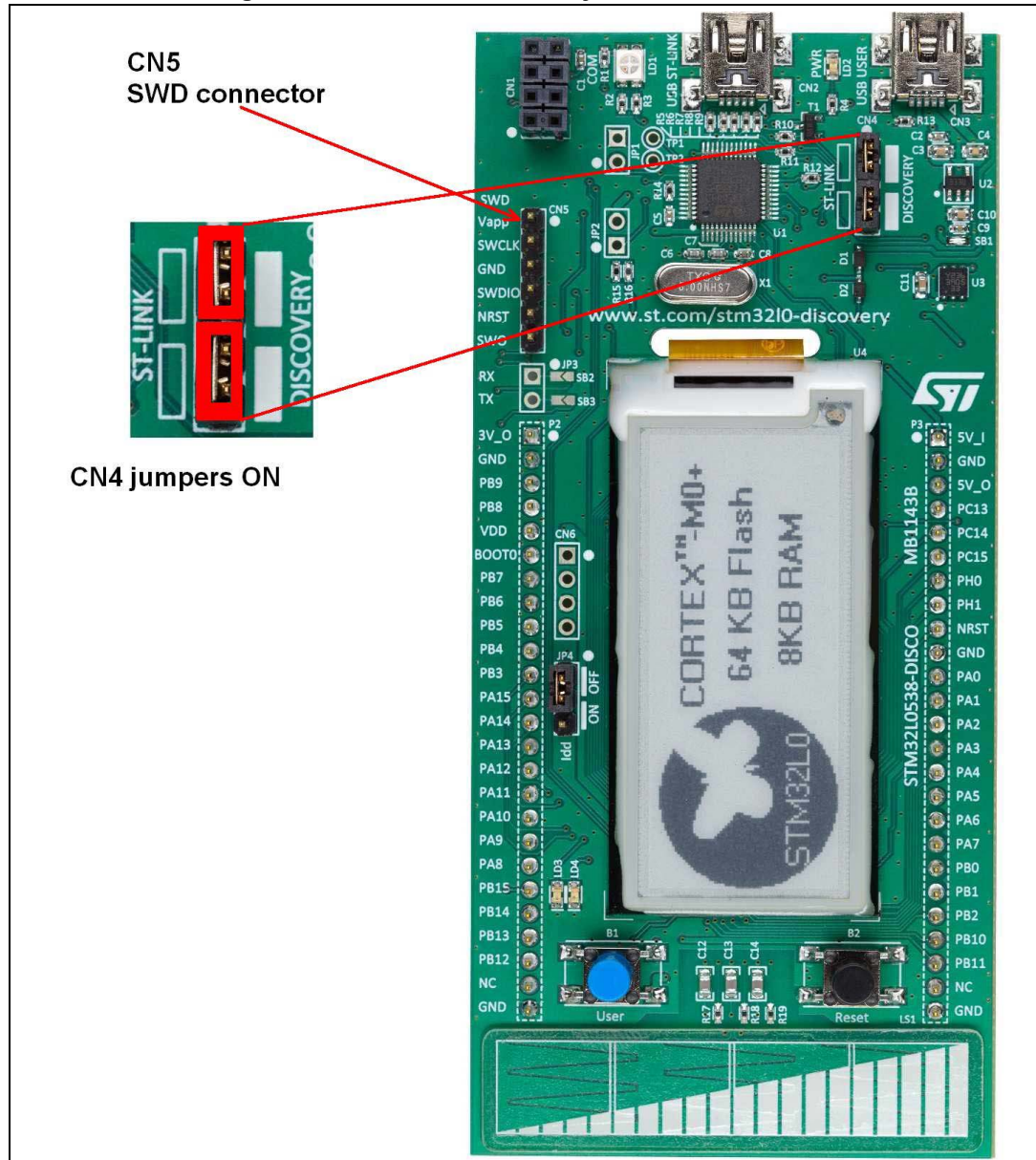

4.1.4 Using ST-LINK/V2-1 to program/debug an external STM32 application

It is very easy to use the ST-LINK/V2-1 to program the STM32 on an external application. Simply remove the 2 jumpers from CN4 as shown in [Figure 7](#) and connect your application to the CN5 debug connector according to [Table 3](#).

Note: SB13, must be OFF if you use CN5 pin 5 (NRST) in your external application.

Table 3. Debug connector CN5 (SWD)

Pin	CN5	Designation
1	VDD_TARGET	VDD from application
2	SWLCK	SWD clock
3	GND	Ground
4	SWDIO	SWD data input/output
5	NRST	RESET of target MCU
6	SWO	Reserved

Figure 7. ST-LINK connections

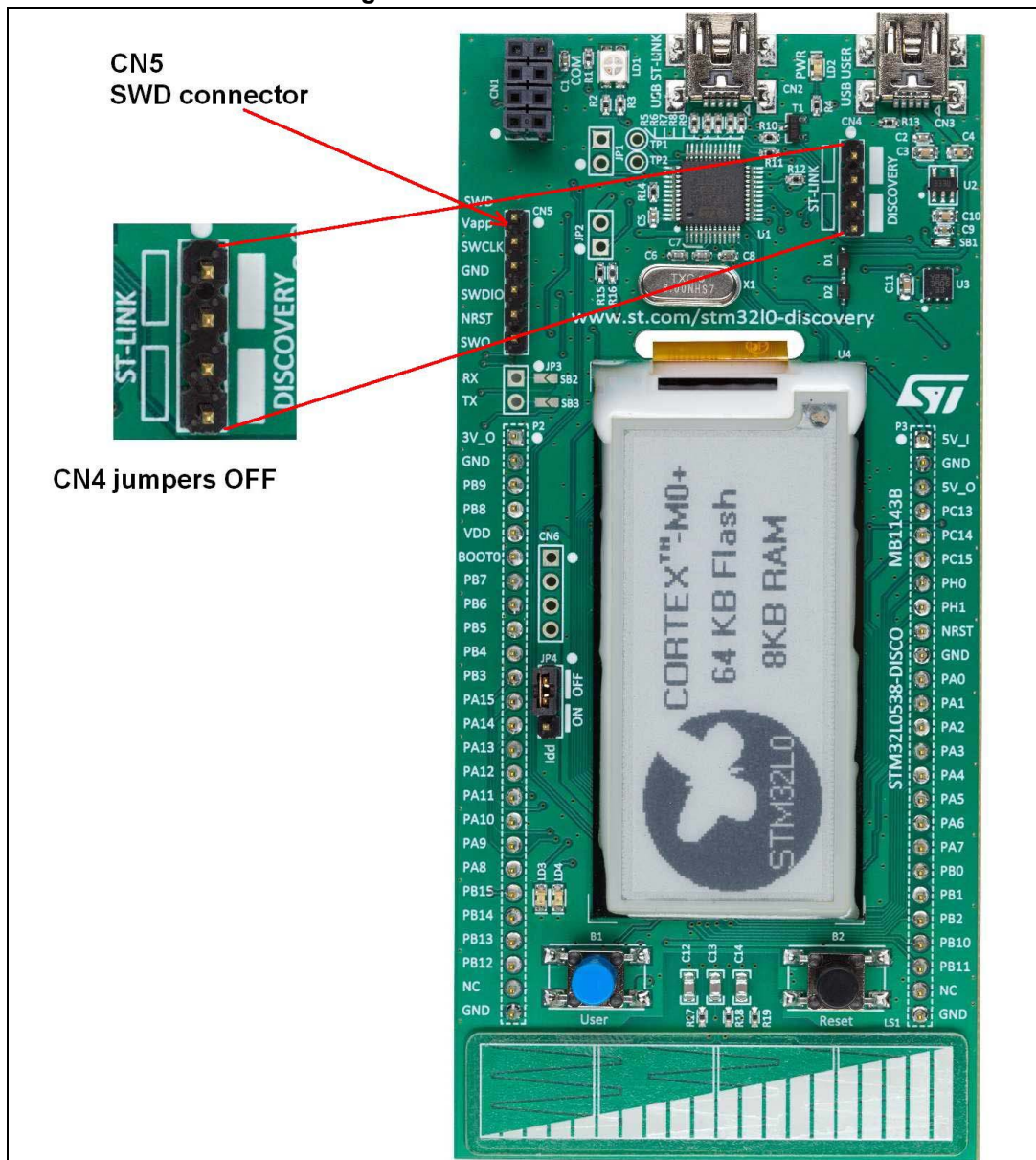

4.2 Power supply and power selection

The power supply is provided either by the host PC through the USB cable, or by an external 5 V power supply.

The STM32L053 discovery board requires to the Host PC 300mA, but around 90mA is needed for its demo, 100mA for an extension board and a safety margin of 100mA.

The D3, D4 and D6 diodes protect the 5 V pins from external power supplies:

- 5 V and 3 V can be used as output power supplies when an extension board is connected to pins P2 and P3.

In this case, the 5V_O and 3V_O pins deliver a 5 V or 3.3 V power supply and the power consumption of the extension board must be lower than 100 mA.

- 5 V can also be used as input power supplies, e.g. when the USB connector is not connected to the PC. (5V_I pin of P3 Header)
In this case, the STM32L053 discovery board must be powered by a power supply unit or by auxiliary equipment complying with standard EN-60950-1: 2006+A11/2009, and must be Safety Extra Low Voltage (SELV) with limited power capability.

4.2.1 Power supply input from the USB connector

The ST-LINK/V2-1 supports USB power management allowing to request more than 100 mA current to the host PC.

All parts of the STM32L053 discovery board and extension board can be powered from the ST-LINK USB connector CN2 (U5V or VBUS). Note that only the ST-LINK part is power supplied before the USB enumeration as the host PC only provides 100 mA to the board at that time. During the USB enumeration, the STM32L053 discovery board requires 300 mA of current to the Host PC. If the host is able to provide the required power, the targeted STM32 microcontroller is powered and the red LED LD2 is turned ON, thus the STM32L053 discovery board and its extension board can consume a maximum of 300 mA current, not more. If the host is not able to provide the required current, the targeted STM32 microcontroller and the MCU part including the extension board are not power supplied. As a consequence the red LED LD2 remains turned OFF. In such case it is mandatory to use an external power supply as explained in the next chapter.

Warning: If the maximum current consumption of the STM32L053 discovery and its extension boards exceeds 300 mA, it is mandatory to power the STM32L053 discovery using an external power supply connected to 5V_IN.

Note: In case of this board is powered by an USB charger or USB battery then there is no USB enumeration so the led LD1 remains OFF permanently and the target MCU is not powered. In this specific case the jumper JP2 needs to be ON to allow target MCU to be powered anyway. This is a special use without enumeration and JP2 is not soldered. To use this optional power supply, solder a 2 pins header in JP2 and set a jumper.

4.2.2 External power supply inputs: 5V_IN or USB USER CN3

The external power source 5V_IN or USB USER CN3 is automatically detected, in this case the current consumption of STM32L053 discovery board and extension board may exceed the allowed current on USB. In this condition it is still possible to use the USB for communication, for programming or debugging only, but it is mandatory to power supply the board first using 5V_IN or USB USER CN3 then connect the USB cable to the PC. Proceeding this way ensures that the enumeration occurs thanks to the external power source.

The following power sequence procedure must be respected:

1. Connect the external power source to 5V_IN or USB USER CN3.
2. Power on the external power supply 5V_IN or USB USER CN3.
3. Check that LD2 is turned ON.
4. Connect the PC to USB connector CN2.

If this order is not respected, the board may be supplied by VBUS first then by 5V_IN or USB USER CN3, and the following risks may be encountered:

1. If more than 300 mA current is needed by the board, the PC may be damaged or the current supply can be limited by the PC. As a consequence the board is not powered correctly.
2. 300 mA is requested at enumeration (since JP2 must be OFF) so there is a risk that the request is rejected and the enumeration does not succeed if the PC cannot provide such current. Consequently the board is not power supplied (LED LD2 remains OFF).

4.3 LEDs

- LD1 COM:
LD1 default status is red. LD1 turns to green to indicate that communications are in progress between the PC and the ST-LINK/V2-1.
- LD2 PWR:
The red LED indicates that the board is powered.
- User LD3:
The green LED is a user LED connected to the I/O PB4 of the STM32L053C8T6.
- User LD4:
The red LED is a user LED connected to the I/O PA5 of the STM32L053C8T6.

4.4 Pushbuttons

- B1 USER:
User and Wake-Up button connected to the I/O PA0 of the STM32L053C8T6.
- B2 RESET:
The pushbutton connected to NRST is used to RESET the STM32L053C8T6.

4.5 NFC connector for PLUG-CR95HF-B board

A NFC (Near Field Communication) transceiver board can be connected to the STM32L053 Discovery board, for example the PLUG-CR95HF-B board.

The NFC board is plugged in connector CN1 of STM32L053 Discovery board as following:

Figure 8. NFC board plugged on STM32L053 discovery



The NFC board can be accessed in SPI or UART mode.

Table 4. NFC connector pin-out

CN1 pin	NFC signals	STM32L053C8T6	Description
1	NFC_IRQOUTN or UART1_TX	PB7	Interrupt output for NFC connected to STM32L053C8T6 UART1 RX
2	NFC_IRQINN or UART1_RX	PB6	Interrupt input for CR95HF connected to STM32L053C8T6 UART1 TX
3	NFC_NSS	PB12	SPI slave select
4	NFC_MISO	PB14	SPI data, slave output
5	NFC_MOSI	PB15	SPI data, slave input
6	NFC_SCK	PB13	SPI serial clock
7	+3V3		Main power supply/power supply for RF drivers
8	GND		Ground

4.6 Electronic Paper Display (EPD)

The STM32L053 Discovery includes an E-Paper PD with High contrast, High reflectance and Ultra wide viewing angle.

This display is a TFT active matrix electrophoretic display. The 2.04" active area contains 172x72 pixels, and has 1-bit and 2-bit full display capabilities. An integrated circuit contains buffers, interface, control logic, oscillator, DC-DC, Etc... (For more information on E-Paper GDE021A1, see www.good-display.com)

The STM32L053C8T6 controls this peripheral and is able to switch off its power supply. (See [Section 6: Electrical schematics](#))

4.7 JP4 (Idd)

Jumper JP4, labeled Idd, allows the consumption of STM32L053C8T6 to be measured directly by a module onboard able to measure from 100 nA to 50 mA or by removing the jumper and connecting an ammeter.

- Jumper on position OFF: STM32L053C8T6 is powered (default).

Figure 9. Jumper on position OFF

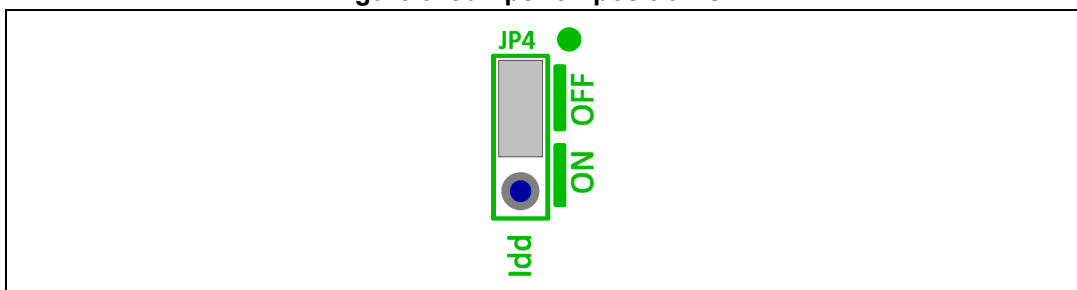

- Jumper on position ON: a module onboard is designed to measure from 100 nA to 50 mA by using several MOSFET and switching automatically depending the read value.

Figure 10. Jumper on position ON

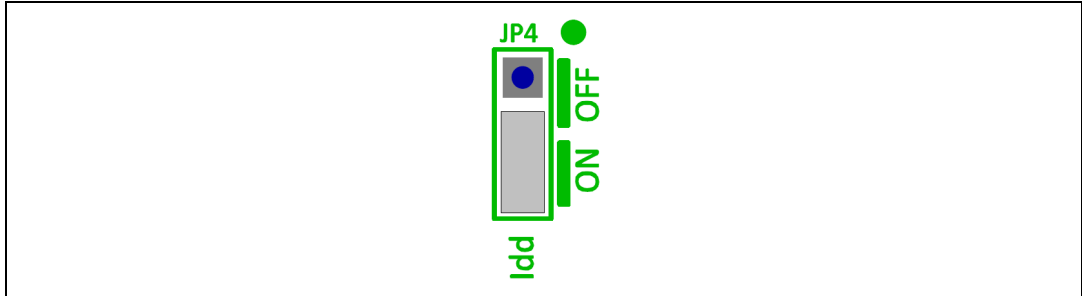

- NO Jumper on JP4: an ammeter must be connected to measure the STM32L053C8T6 current through pin 1 and 2 (if there is no ammeter, the STM32L053C8T6 is not powered).

Figure 11. No Jumper

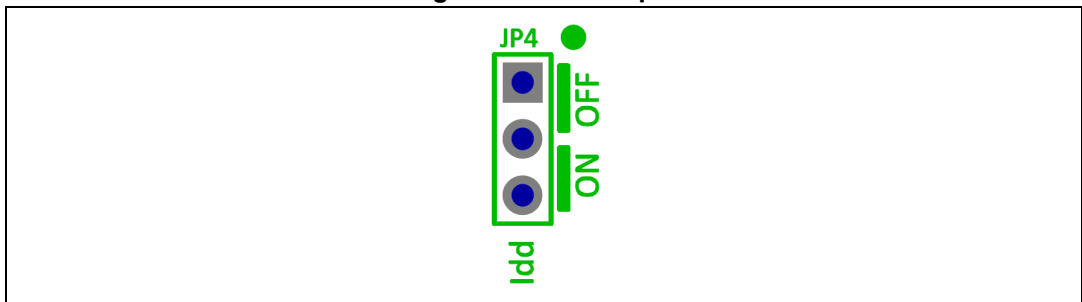

4.8 BOOT0 configuration

BOOT0 is at level "0" through a pull-down R65. If you want to set BOOT0 at level "1", it can be configured by setting a jumper between P2.6 (BOOT0) and P2.5 (VDD).

Note: If you need to set BOOT0 at level "1" continuously, then unsolder the resistor R65 to avoid a consumption of 6 mA while connecting pin P2.6 (BOOT0) and P2.5 (VDD) with a jumper or with a wire.

4.9 Linear touch sensor / touch keys

To demonstrate touch sensing capabilities, the STM32L053 discovery includes a linear touch sensor which can be used either as a 3-position linear touch sensor or as 4 touch keys. Both functions are illustrated in the demonstration software.

3 pairs of I/O ports are assigned to the linear touch sensor / touch keys. Each pair must belong to the same analog switch group:

- PA2, PA3 (group 1)
- PA6, PA7 (group 2)
- PB0, PB1 (group 3)

To minimize the noise, these pairs are dedicated to the linear touch sensor and the touch keys and are not connected to external headers. To design a touch sensing application, refer to the following documentation and firmware:

- For details concerning I/O ports, refer to the STM32L053C8T6 datasheet.
- For information on software development, see DISCOVER application software on www.st.com/stm32l0-discovery.
- For more detail concerning touch sensing application design and layout, refer to AN2869 -Guidelines for designing touch sensing applications.
- STM32 touch sensing library available from www.st.com/stm32l0-discovery.

The STM32L053C8T6 MCU controls the linear touch sensor and the touch keys.

4.10 USB device support

The STM32L053C8T6 MCU is also used to drive the second USB mini-B connector (USB USER) which allows the board to be used as a USB Device. The STM32L053 discovery can then act as a USB joystick, mouse, or other similar device. If both USBs are connected, diodes D3 and D4 protect the board and use the power from the USB ST-LINK or USB USER. [Section 4.2.2: External power supply inputs: 5V_IN or USB USER CN3](#).

The board can be powered through this USB USER connector, in which case LED2 PWR lights up, LED1 COM blinks and it can run an application in standalone mode.

The STM32L053C8T6 MCU controls the USB USER through PA11 and PA12.

4.11 USART configuration

The USART1 interface available on PA9 and PA10 of the STM32L053C8T6 can be connected to ST-LINK MCU to use the Virtual Com Port function.

By default the USART1 communication between the target STM32L053C8T6 and ST-LINK MCU is not enabled.

To use the Virtual Com Port function with:

- The onboard STM32L053C8T6, then set SB2 and SB3 ON. (SB14,15 must be OFF)
- An external MCU then remove solder from SB2 and SB3, solder a 2 pins header on JP3, then you can connect RX and TX of the external MCU directly to RX and TX of JP3. (for more details see [Section 6: Electrical schematics](#))

4.12 OSC clock supply

If PH0 is only used as GPIOs instead of as a clock, then SB21 is closed. (SB20 must be open)

MCO from ST-LINK (from MCO of the STM32F103CBT6)

This frequency cannot be changed, it is fixed at 8 MHz and connected to PH0-OSC_IN of the STM32L053C8T6. The configuration needed is:

- SB20 closed and SB21 open

Oscillator from external PH0 (from external oscillator through pin 7 of the P3 connector)

The configuration needed is:

- SB21 closed and SB20 open

Note: Please refer to the AN2867 for oscillator design guide for STM32 microcontrollers.

4.13 OSC 32 kHz clock supply

If PC14 and PC15 are only used as GPIOs instead of as a clock, then SB18 and SB19 are closed and R70 and R71 are removed.

HSE Oscillator onboard from X2 crystal (not provided)

For typical frequencies and its capacitors and resistors, please refer to the STM32L053C8T6 Datasheet. The configuration needed is:

- SB18, SB19 open
- X2, R70, R71, C47, C50 soldered

Oscillator from external PC14 (from external oscillator through pin 5 of the P3 connector)
the configuration needed is:

- SB18 closed
- SB19 open
- R70 removed

Note: Please refer to the AN2867 for oscillator design guide for STM32 microcontrollers.

4.14 Solder bridges

Table 5. Solder bridges

Bridge	State ⁽¹⁾	Description
SB18, 19 (X2 crystal)	OFF	X2, C47, C50, R70 and R71 provide a clock. PC14, PC15 are disconnected from P3.
	ON	PC14, PC15 are connected from P3. Remove only R70 and R71
SB7,8,9,12 (default)	ON	Reserved, do not modify
SB4,5,6,11 (reserved)	OFF	Reserved, do not modify
SB2,3 (reserved)	OFF	Reserved, do not modify
SB29 (B2-RESET)	ON	B2 Push Button is connected to NRST of STM32L053C8T6
	OFF	B2 Push Button is not connected to NRST of STM32L053C8T6
SB22 (B1-USER)	ON	B1 Push Button is connected to PA0
	OFF	B1 Push Button is not connected to PA0
SB14, 15 (RX, TX)	OFF	PA2, PA3 of STM32F103CBT6 are not connected to PB4, PB3 of STM32L053C8T6
	ON	PA2, PA3 of STM32F103CBT6 are connected to PB4, PB3 of STM32L053C8T6
SB16, 17 (USB_USER)	OFF	USB1_DP and USB1_DM are dedicated to the USB USER connector CN3
	ON	USB1_DP is connected to PA12 and USB1_DM is connected to PA11. Both are available as GPIO on P2, P3 headers.
SB23,24,25,26,27,28 (touch sensor)	OFF	PA2, PA3, PA6, PA7, PB0, PB1 are dedicated to touch sensor.
	ON	PA2, PA3, PA6, PA7, PB0, PB1 are available as GPIO on P2, P3 headers.
SB1 (ST-LINK PWR)	ON	ST-LINK module is powered
	OFF	ST-LINK module is not powered
SB21 (OSC_IN)	OFF	Clock signal from header P3.7 is connected to OSC_IN of STM32L053C8T6 or PH0 is available as GPIO. SB20 must be OFF
	ON	No connection between header P3.7 and PH0 of STM32L053C8T6
SB13 (NRST)	ON	T_NRST signal from connector CN5 and STM32F103CBT6, is connected to NRST of STM32L053C8T6
	OFF	T_NRST signal is not connected
SB10 (STM_RST)	OFF	No incidence on NRST signal of STM32F103CBT6
	ON	NRST signal of STM32F103CBT6 is connected to GND
SB20 (MCO)	ON	MCO clock signal from STM32F103CBT6 is connected to OSC_IN of STM32L053C8T6. SB21 must be OFF
	OFF	MCO signal of STM32F103CBT6 is not used.

1. Default value is in bold.

4.15 Extension connectors

The male headers P2 and P3 can connect the STM32L053 discovery board to a standard prototyping/wrapping board. STM32L053C8T6 GPIOs are available on these connectors. P2 and P3 can also be probed by an oscilloscope, logical analyzer or voltmeter.

Table 6. Extension connectors

MCU pin		Board function															
Main function	LQFP48 pin num.	SYSTEM	VCP	PushButtons	LED	NFC CR95HF-B	USB USER	Linear touch sensor	E-paper Display	Idd Measure	Free I/O	Power Supply	P2	P3	CN1	CN3	SBx ⁽¹⁾
BOOT0	44	BOOT0	-	-	-	-	-	-	-	-	-	-	6	-	-	-	-
NRST	7	NRST	-	-	-	-	-	-	-	-	-	-	-	9	-	-	-
PA0	10	-	-	BP_USER	-	-	-	-	-	-	-	-	-	11	-	-	-
PA1	11	-	-	-	-	-	-	-	-	MFX_WAKEUP	-	-	-	12	-	-	-
PA2	12	-	-	-	-	-	-	TS_G1_IO3	-	-	-	-	-	13	-	-	SB28
PA3	13	-	-	-	-	-	-	TS_G1_IO4	-	-	-	-	-	14	-	-	SB27
PA4	14	-	-	-	-	-	-	-	-	-	PA4	-	-	15	-	-	-
PA5	15	-	-	-	-	RED	-	-	-	-	-	-	-	16	-	-	-
PA6	16	-	-	-	-	-	-	TS_G2_IO3	-	-	-	-	-	17	-	-	SB26

Table 6. Extension connectors (continued)

MCU pin		Board function															
Main function	LQFP48 pin num.	SYSTEM	VCP	PushButtons	LED	NFC CR95HF-B	USB USER	Linear touch sensor	E-paper Display	Idd Measure	Free I/O	Power Supply	P2	P3	CN1	CN3	SBx ⁽¹⁾
PA7	17	-	-	-	-	-	-	TS_G2_IO4	-	-	-	-	-	18	-	-	SB25
PA8	29	-	-	-	-	-	-	-	ePD1_BUSY	-	-	-	19	-	-	-	-
PA9	30	-	USART_TX	-	-	-	-	-	-	-	-	-	18	-	-	-	-
PA10	31	-	USART_RX	-	-	-	-	-	-	-	-	-	17	-	-	-	-
PA11	32	-	-	-	-	-	USB_DM	-	-	-	-	-	16	-	-	2 ⁽²⁾	SB17
PA12	33	-	-	-	-	-	USB_DP	-	-	-	-	-	15	-	-	3 ⁽²⁾	SB16
PA13	34	SWDIO	-	-	-	-	-	-	-	-	-	-	14	-	-	-	-
PA14	37	SWCLK	-	-	-	-	-	-	-	-	-	-	13	-	-	-	-
PA15	38	-	-	-	-	-	-	-	ePD1_CS	-	-	-	12	-	-	-	-
PB0	18	-	-	-	-	-	-	TS_G3_IO2	-	-	-	-	-	19	-	-	SB24



Table 6. Extension connectors (continued)

MCU pin		Board function															
Main function	LQFP48 pin num.	SYSTEM	VCP	PushButtons	LED	NFC CR95HF-B	USB USER	Linear touch sensor	E-paper Display	Idd Measure	Free I/O	Power Supply	P2	P3	CN1	CN3	SBx ⁽¹⁾
PB1	19	-	-	-	-	-	-	TS_G3_IO3	-	-	-	-	-	20	-	-	SB23
PB2	20	-	-	-	-	-	-	-	ePD1_RESET	-	-	-	-	21	-	-	-
PB3	39	-	-	-	-	-	-	-	ePD1_SCK	-	-	-	11	-	-	-	-
PB4	40	-	-	-	GREEN	-	-	-	-	-	-	-	10	-	-	-	-
PB5	41	-	-	-	-	-	-	-	ePD1_MOSI	-	-	-	9	-	-	-	-
PB6	42	-	-	-	-	NFC_IRQINN	-	-	-	-	-	-	8	-	2	-	-
PB7	43	-	-	-	-	NFC_IRQOUTN	-	-	-	-	-	-	7	-	1	-	-
PB8	45	-	-	-	-	-	-	-	-	MFX_I2C_SCL	-	-	4	-	-	-	-

Table 6. Extension connectors (continued)

MCU pin		Board function															
Main function	LQFP48 pin num.	SYSTEM	VCP	PushButtons	LED	NFC CR95HF-B	USB USER	Linear touch sensor	E-paper Display	Idd Measure	Free I/O	Power Supply	P2	P3	CN1	CN3	SBx ⁽¹⁾
PB9	46	-	-	-	-	-	-	-	-	MFX_I2C_SDA	-	-	3	-	-	-	-
PB10	21	-	-	-	-	-	-	-	ePD1_PWR8ENn	-	-	-	-	22	-	-	-
PB11	22	-	-	-	-	-	-	-	ePD1_D/C	-	-	-	-	23	-	-	-
PB12	25	-	-	-	-	NFC_NSS	-	-	-	-	-	-	23	-	3	-	-
PB13	26	-	-	-	-	NFC_SCK	-	-	-	-	-	-	22	-	6	-	-
PB14	27	-	-	-	-	NFC_MISO	-	-	-	-	-	-	21	-	4	-	-
PB15	28	-	-	-	-	NFC_MOSI	-	-	-	-	-	-	20	-	5	-	-
PC13	2	-	-	-	-	-	-	-	-	MFX_IRQ_OUT	-	-	-	4	-	-	-

Table 6. Extension connectors (continued)

MCU pin		Board function															
Main function	LQFP48 pin num.	SYSTEM	VCP	PushButtons	LED	NFC CR95HF-B	USB USER	Linear touch sensor	E-paper Display	Idd Measure	Free I/O	Power Supply	P2	P3	CN1	CN3	SBx ⁽¹⁾
PC14	3	OSC32_IN	-	-	-	-	-	-	-	-	PC14	-	-	5	-	-	-
PC15	4	OSC32_OUT	-	-	-	-	-	-	-	-	PC15	-	-	6	-	-	-
PH0	5	OSC_IN	-	-	-	-	-	-	-	-	-	-	-	7	-	-	-
PH1	6	-	-	-	-	-	-	-	-	-	PH1	-	-	8	-	-	-
.	.	-	-	-	-	-	-	-	-	-	-	5V_USB_USER	-	-	-	1	-
.	.	-	-	-	-	-	-	-	-	-	-	3V3	1	-	7	-	-
.	.	-	-	-	-	-	-	-	-	-	-	5V_IN	-	1	-	-	-
.	.	-	-	-	-	-	-	-	-	-	-	5V_OUT	-	3	-	-	-
VDD	24	-	-	-	-	-	-	-	-	-	-	VDD	5	-	-	-	-
VDD	48	-	-	-	-	-	-	-	-	-	-	VDD	-	-	-	-	-
VDD_USB	36	-	-	-	-	-	-	-	-	-	-	VDD	-	-	-	-	-
VDDA	9	-	-	-	-	-	-	-	-	-	-	-	-	-	-	-	-
VLCD	1	-	-	-	-	-	-	-	-	-	-	VDD	-	-	-	-	-
VSS	23	-	-	-	-	-	-	-	-	-	-	GND	2	2	8	4 ⁽²⁾	-

Table 6. Extension connectors (continued)

MCU pin		Board function															
Main function	LQFP48 pin num.	SYSTEM	VCP	PushButtons	LED	NFC CR95HF-B	USB USER	Linear touch sensor	E-paper Display	Idd Measure	Free I/O	Power Supply	P2	P3	CN1	CN3	SBx ⁽¹⁾
VSS	35	-	-	-	-	-	-	-	-	-	-	GND	25	10	-	5	-
VSS	47	-	-	-	-	-	-	-	-	-	-	GND	-	25	-	6	-
VSSA	8	-	-	-	-	-	-	-	-	-	-	GND	-	-	-	-	-
-	-	-	-	-	-	-	-	-	-	-	-	NC	24	24	-	-	-

1. Signals available depending on SBx value. Refer to [Table 5: Solder bridges](#) or schematics in [Section 6](#).
2. Connected through a resistor

5 Mechanical drawing

Figure 12. STM32L053 discovery board mechanical drawing

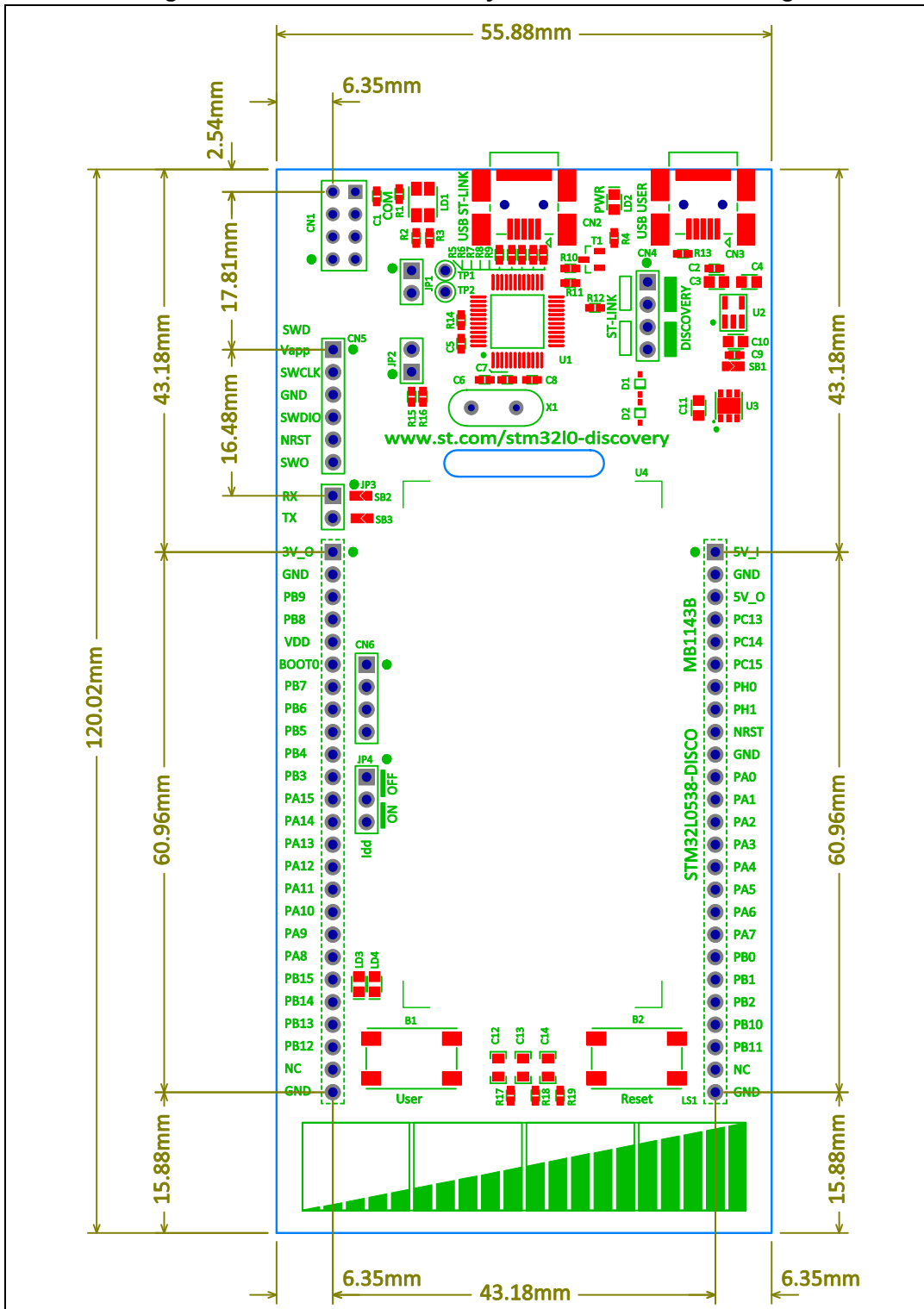

6 Electrical schematics

Figure 13. STM32L053 discovery

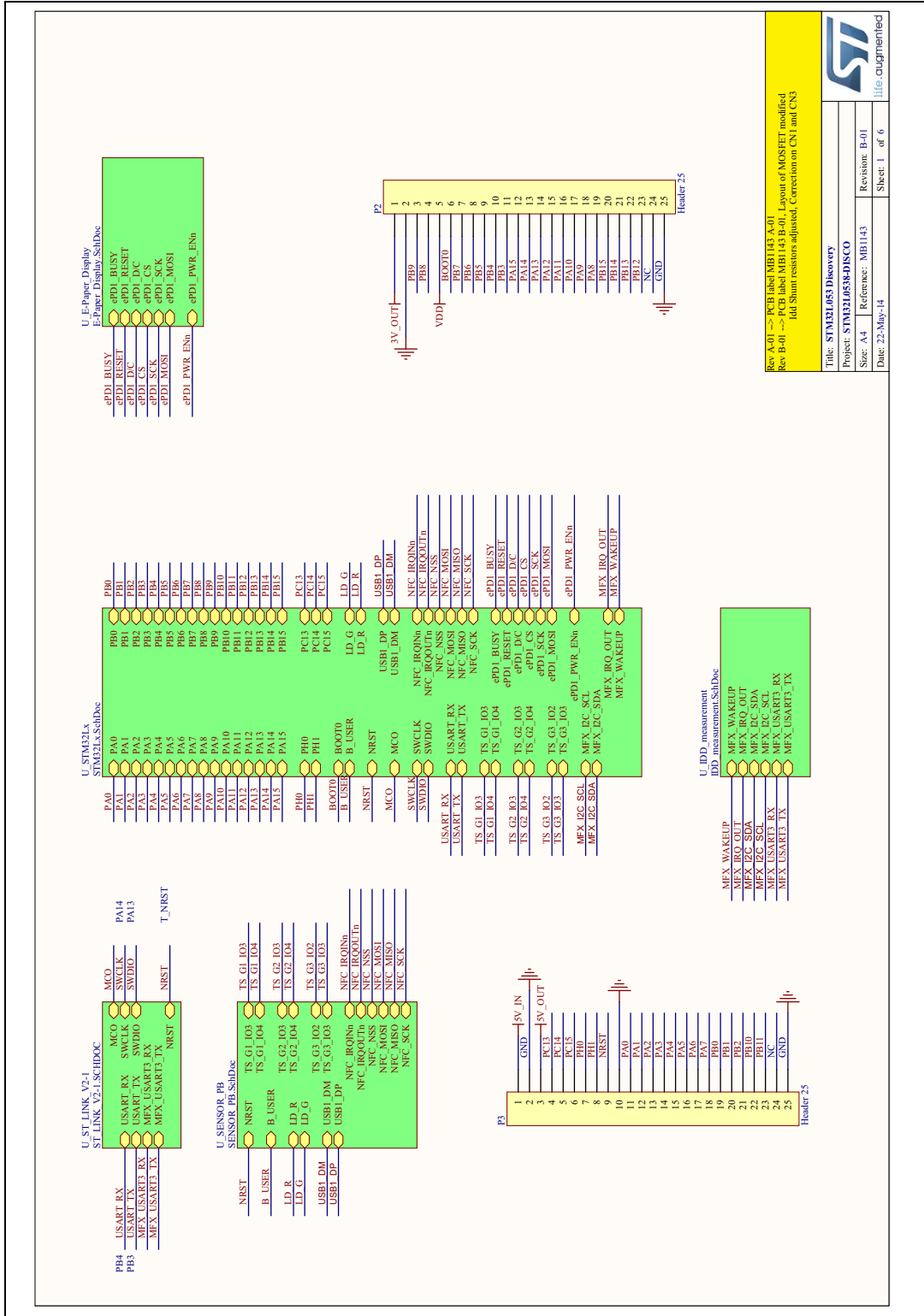

Rev A-01 -> PCB label MB1145 A-01
 Rev B-01 -> PCB label MB1145 B-01, 1. Count of MOSFET modified
 Id: Shun revision updated, Correction on CN1 and CN3

	
Title: STM32L053 Discovery	
Project: STM32L053-DSICO	
Size: A4	Reference: MB1145
Date: 22-May-14	Revision: B-01
	Sheet: 1 of 6

Figure 14. ST-LINK/V2-1 (SWD only)

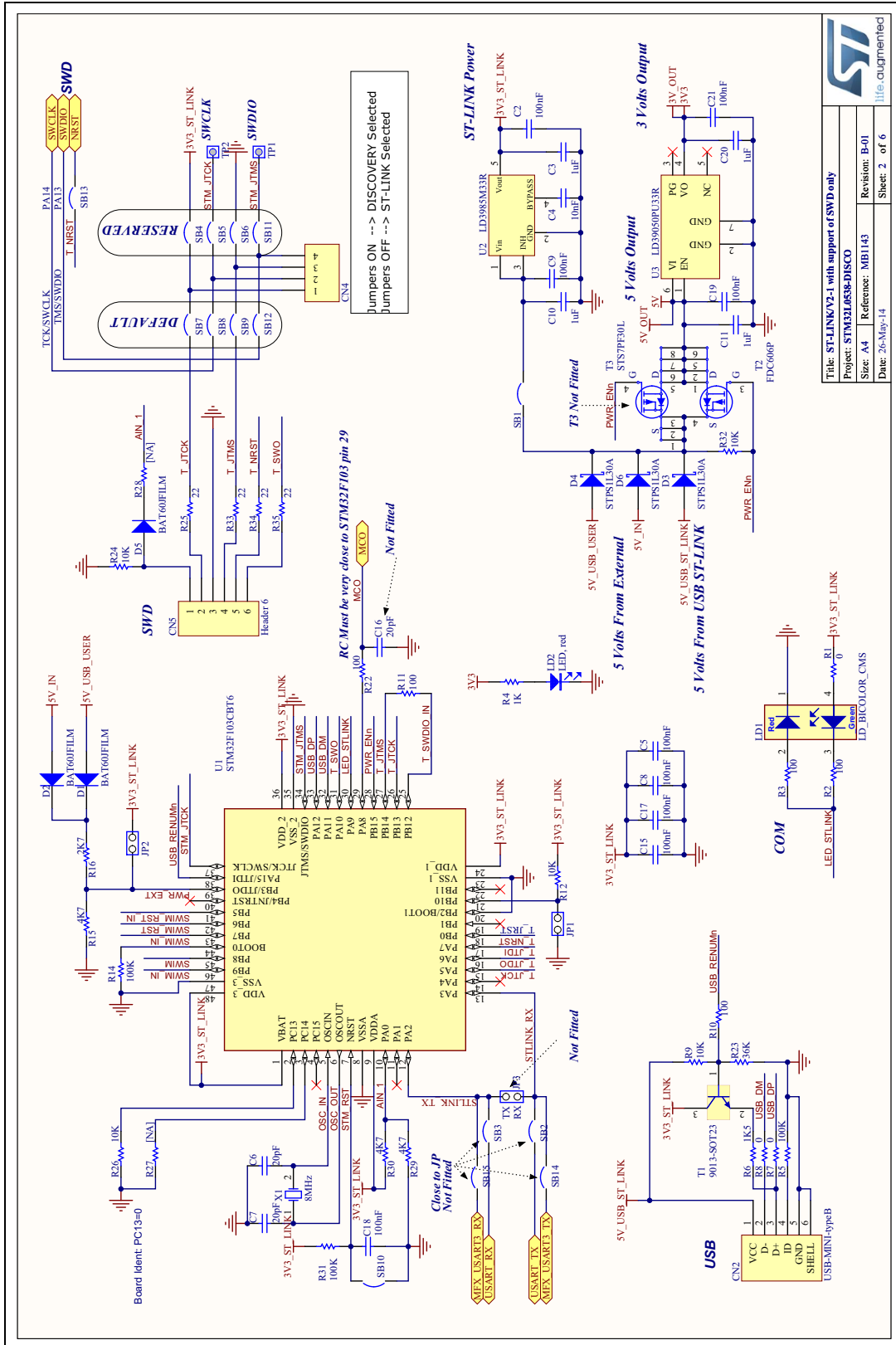
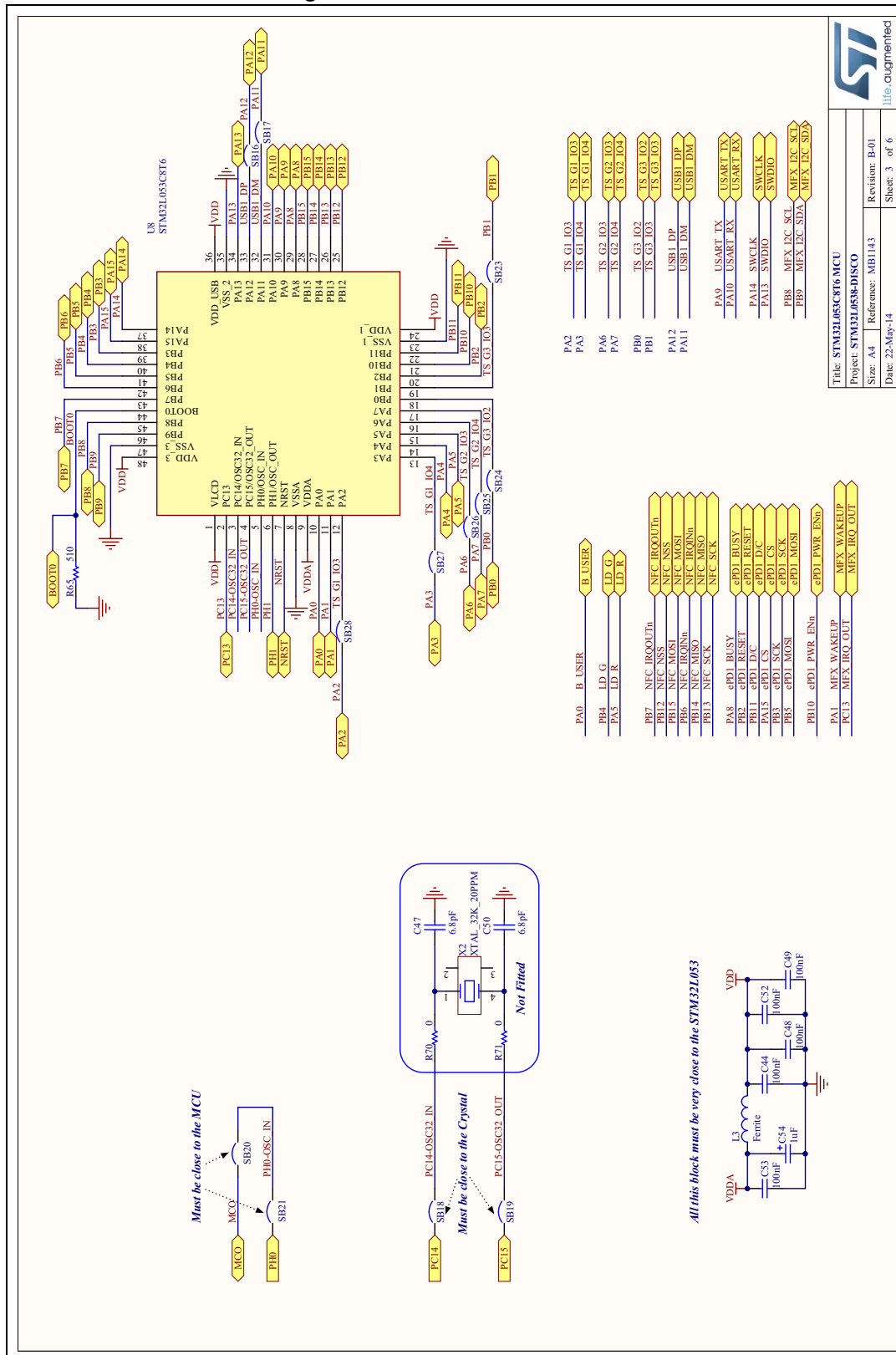

Figure 15. STM32L053C8T6 MCU



Must be close to the MCU

Must be close to the Crystal

All this block must be very close to the STM32L053

Title: STM32L053C8T6 MCU
Project: STM32L0538-DS8CO
 Size: A4 Reference: MB1143 Revision: B-01
 Date: 22-May-14 Sheet: 3 of 6



Figure 17. Linear touch sensor, NFC, USB and pushbutton

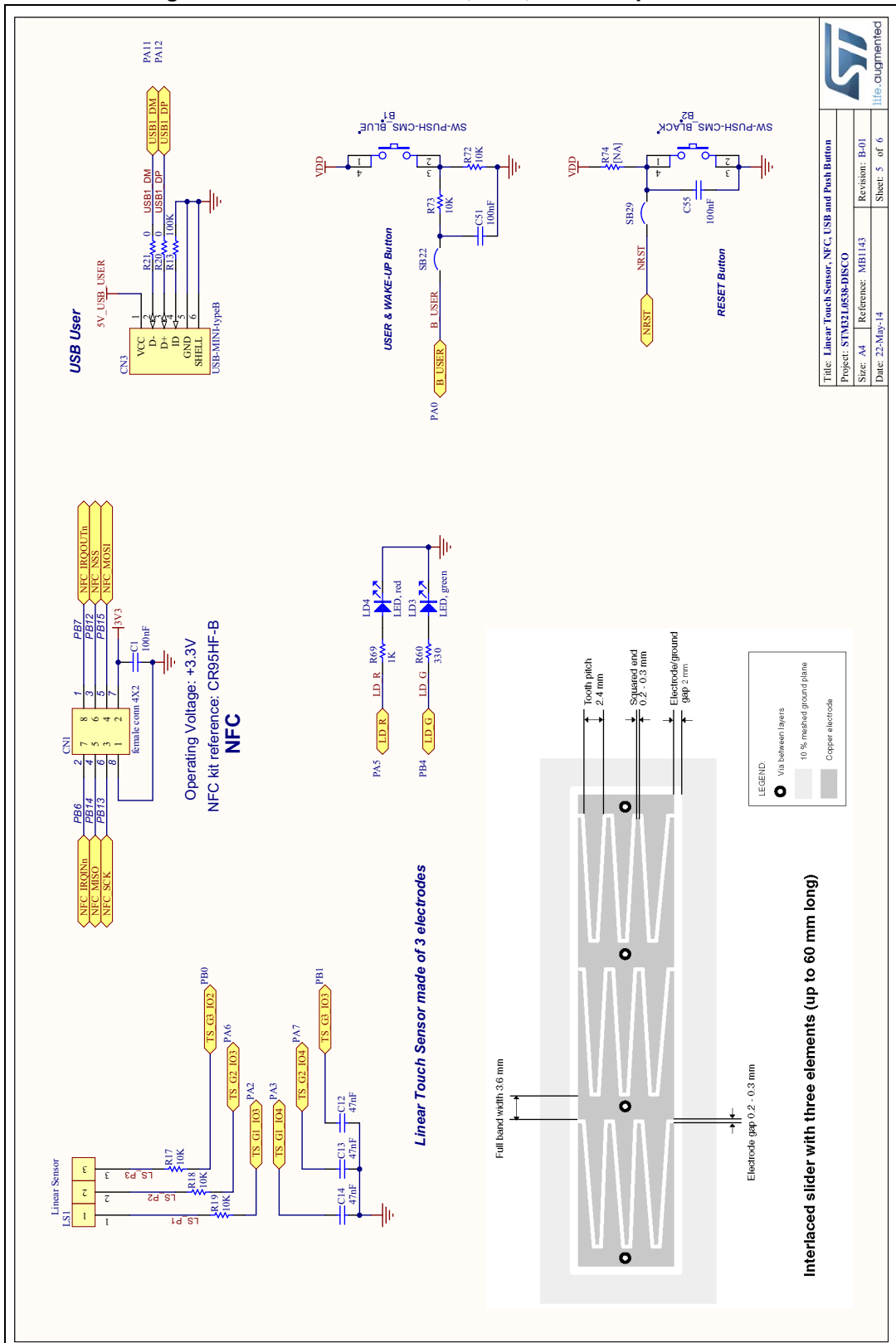

	
Title: Linear Touch Sensor, NFC, USB and Push Button Project: STM32L0538-DISCO	
Size: A4	Reference: MB1143
Date: 22-May-14	Revision: B-01
	Sheet: 5 of 6

Figure 18. IDD measurement / MFX (Multi Function eXpander)



7 Revision history

Table 7. Document revision history

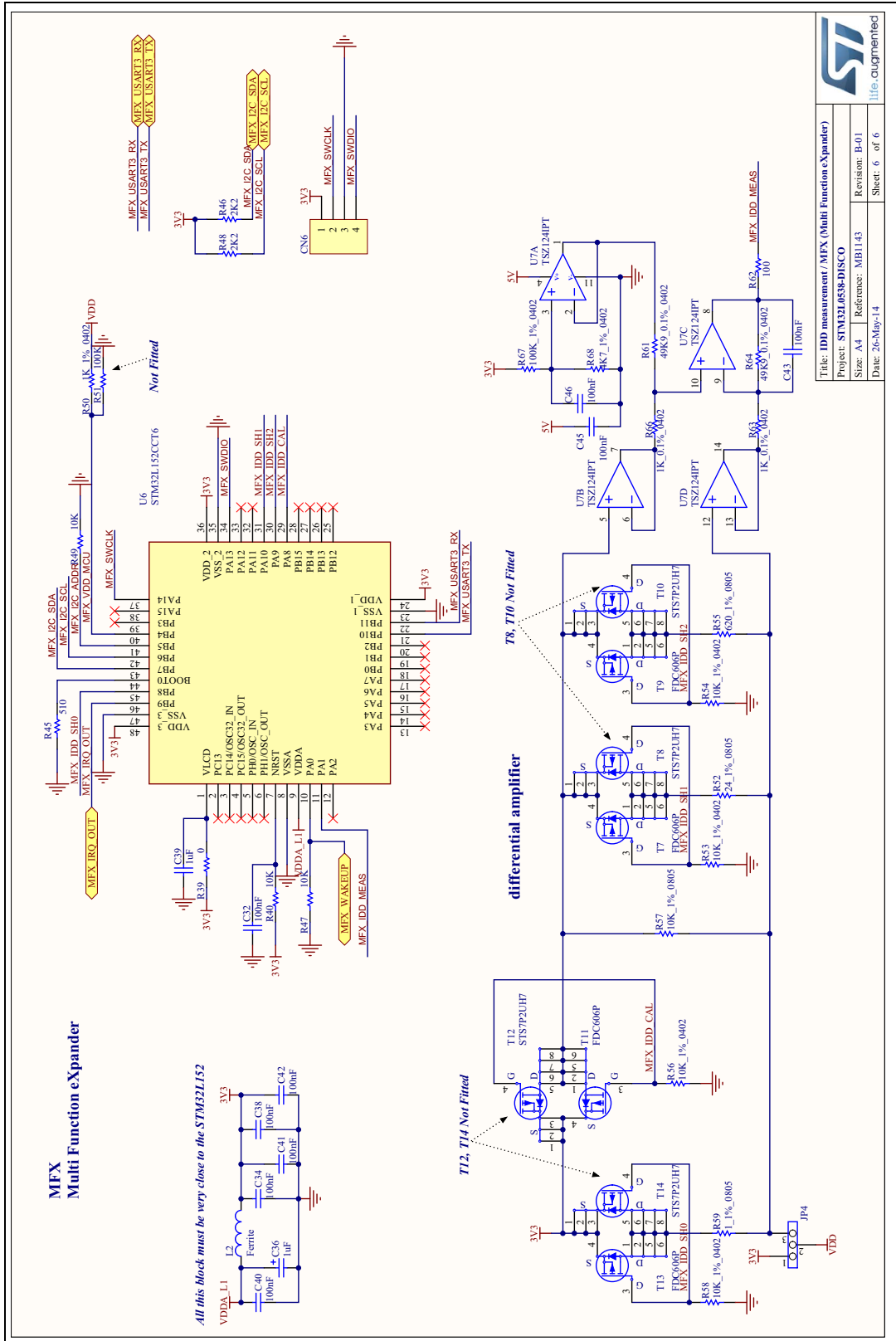
Date	Revision	Changes
20-June-2014	1	initial release
24-June-2014	2	Removed embedded USB bootloader paragraph.

Please Read Carefully:

Information in this document is provided solely in connection with ST products. STMicroelectronics NV and its subsidiaries ("ST") reserve the right to make changes, corrections, modifications or improvements, to this document, and the products and services described herein at any time, without notice.

All ST products are sold pursuant to ST's terms and conditions of sale.

Purchasers are solely responsible for the choice, selection and use of the ST products and services described herein, and ST assumes no liability whatsoever relating to the choice, selection or use of the ST products and services described herein.

No license, express or implied, by estoppel or otherwise, to any intellectual property rights is granted under this document. If any part of this document refers to any third party products or services it shall not be deemed a license grant by ST for the use of such third party products or services, or any intellectual property contained therein or considered as a warranty covering the use in any manner whatsoever of such third party products or services or any intellectual property contained therein.

UNLESS OTHERWISE SET FORTH IN ST'S TERMS AND CONDITIONS OF SALE ST DISCLAIMS ANY EXPRESS OR IMPLIED WARRANTY WITH RESPECT TO THE USE AND/OR SALE OF ST PRODUCTS INCLUDING WITHOUT LIMITATION IMPLIED WARRANTIES OF MERCHANTABILITY, FITNESS FOR A PARTICULAR PURPOSE (AND THEIR EQUIVALENTS UNDER THE LAWS OF ANY JURISDICTION), OR INFRINGEMENT OF ANY PATENT, COPYRIGHT OR OTHER INTELLECTUAL PROPERTY RIGHT.

ST PRODUCTS ARE NOT DESIGNED OR AUTHORIZED FOR USE IN: (A) SAFETY CRITICAL APPLICATIONS SUCH AS LIFE SUPPORTING, ACTIVE IMPLANTED DEVICES OR SYSTEMS WITH PRODUCT FUNCTIONAL SAFETY REQUIREMENTS; (B) AERONAUTIC APPLICATIONS; (C) AUTOMOTIVE APPLICATIONS OR ENVIRONMENTS, AND/OR (D) AEROSPACE APPLICATIONS OR ENVIRONMENTS. WHERE ST PRODUCTS ARE NOT DESIGNED FOR SUCH USE, THE PURCHASER SHALL USE PRODUCTS AT PURCHASER'S SOLE RISK, EVEN IF ST HAS BEEN INFORMED IN WRITING OF SUCH USAGE, UNLESS A PRODUCT IS EXPRESSLY DESIGNATED BY ST AS BEING INTENDED FOR "AUTOMOTIVE, AUTOMOTIVE SAFETY OR MEDICAL" INDUSTRY DOMAINS ACCORDING TO ST PRODUCT DESIGN SPECIFICATIONS. PRODUCTS FORMALLY ESCC, QML OR JAN QUALIFIED ARE DEEMED SUITABLE FOR USE IN AEROSPACE BY THE CORRESPONDING GOVERNMENTAL AGENCY.

Resale of ST products with provisions different from the statements and/or technical features set forth in this document shall immediately void any warranty granted by ST for the ST product or service described herein and shall not create or extend in any manner whatsoever, any liability of ST.

ST and the ST logo are trademarks or registered trademarks of ST in various countries.

Information in this document supersedes and replaces all information previously supplied.

The ST logo is a registered trademark of STMicroelectronics. All other names are the property of their respective owners.

© 2014 STMicroelectronics - All rights reserved

STMicroelectronics group of companies

Australia - Belgium - Brazil - Canada - China - Czech Republic - Finland - France - Germany - Hong Kong - India - Israel - Italy - Japan - Malaysia - Malta - Morocco - Philippines - Singapore - Spain - Sweden - Switzerland - United Kingdom - United States of America

www.st.com

